



Delvcam

DELV-HDMIB

User Guide



Important Safety Instructions:

- Please read User Guide before using this product.
- Please keep User Guide for future reference.
- Please read the cautions to prevent possible danger and loss of property.

Contents

Features	2
Safety Instructions	2
Installation & Initial Setup	3
Product Description	4
Sunshade Installation	6
DV Battery Mount Plate (Optional)	6
Wiring Instructions	7
Menu Settings	8
Technical Specifications	12
Trouble Shooting	12

Features

- High resolution: 1280×800;
- High brightness: 400cd/m²;
- High contrast: 800:1;
- Built-in battery & battery level;
- HDMI & AV input;
- Foldable sun shade;

Safety Instructions

- Please do not place the display screen face down.
- Please do not drop onto the ground and avoid heavy impact.
- Please do NOT use chemical solutions to clean this product. Please wipe with a clean soft cloth to maintain the brightness of the surface.
- Please do not block any ventilation or antenna ports.
- Please follow the instructions and trouble-shootings to adjust the product. Other improper adjustment may result in damage. Any further adjustment must be performed or conducted by a qualified technician.
- Please unplug the power and remove the battery for long-term storage, or during lightning storms.

Installation & Initial Setup

❖ Unpacking

Carefully unpack the monitor and verify that the following items are included:

- Monitor
- Sun shade
- AV input cable
- AV output cable
- 12V DC adapter
- HDMI A/C cable
- Shoe mount
- 2600mAh built-in battery
- Manual



Inspect the unit for any physical damage that may have occurred during shipping. Should there be any damage, please immediately contact us.

❖ Optional Accessories

Accessory options. (Sold Separately)

- VESA battery plate + Battery plate
- VESA folding bracket
- Mount plate bracket
- Anton Bauer / V-mount mount
- VESA rail slot
- Li-ion battery



Tip: Use original accessories to prevent device from damage.

Product Description

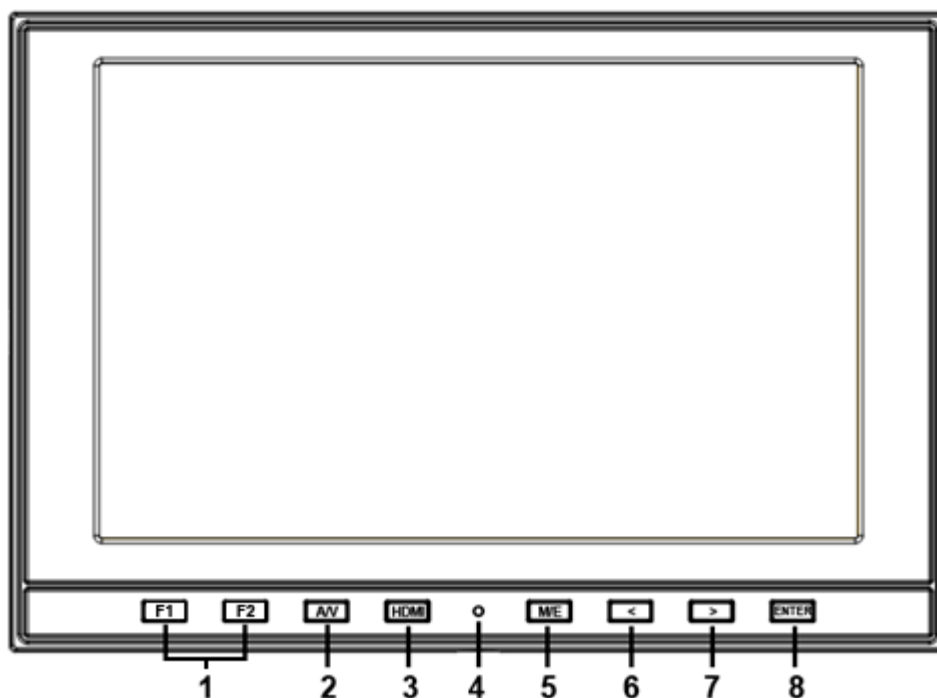

1. F1、 F2 User-definable buttons.
2. A/V: switch to AV state.
3. HDMI: switch to HDMI state.
4. Battery indicator
Status 1: the indicator light turns to fully red when battery charging.
Status 2: the indicator light turns to half red when powered with DC power, but not with battery.
Status 3: the indicator light turns to off when charge completely or use only with battery.
5. M/E: to activate OSD (on-screen display) menu.
Select switch the brightness, contrast, saturation, Tint, sharpness, volume, MENU and Exit.
6. < Left selection key, to select items on OSD menu and value option adjustment:
Press to adjust the brightness, contrast, saturation, Tint, sharpness and volume value decrease.
7. > Right selection key, to select items on OSD menu, value option adjustment and confirmation:
Press to adjust the brightness, contrast, saturation, Tint, sharpness and volume value increase.
8. ENTER.

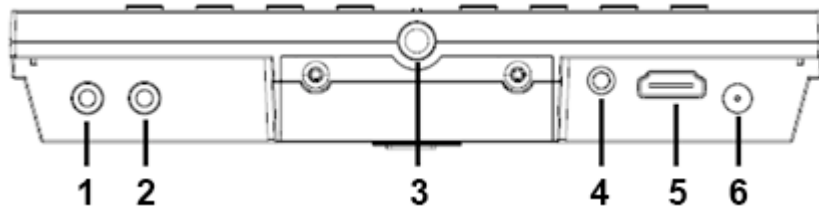

1. OUT: video output interface.
2. IN: video input interface.
3. Bracket mount (Depth limit 0.5cm).
4. Earphone jack.
5. HDMI input interface.
6. POWER: DC12V power input.

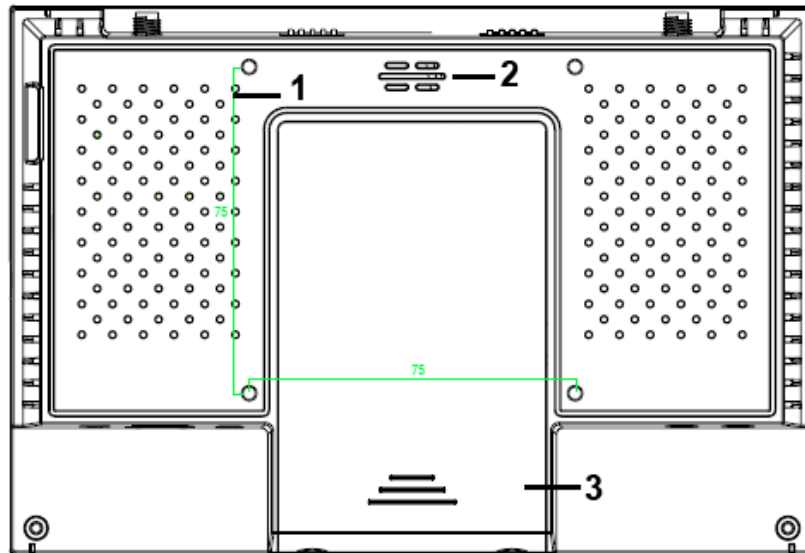

1. VESA mounting interface.
2. Speaker.
3. 2600mA battery slot (**built-in**).

Sunshade Installation



DV Battery Mount Plate (Optional)

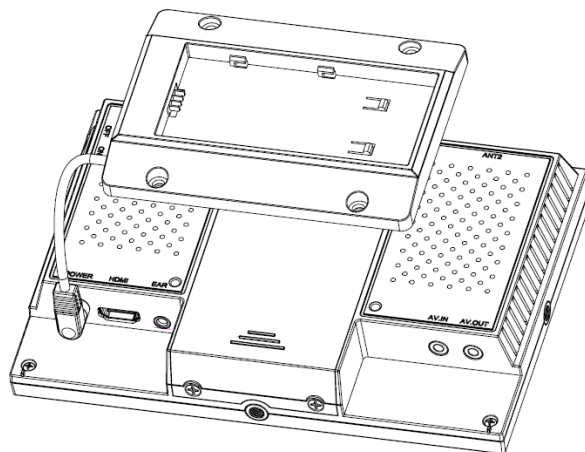

Following three types of battery plates are suitable for this device, model F970, QM91D, DU21 & LP-E6 (choose 2 out of 4).

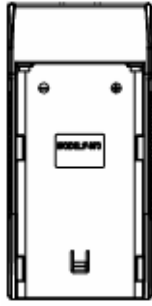

MODEL: F-970

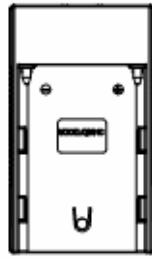

MODEL: QM91D

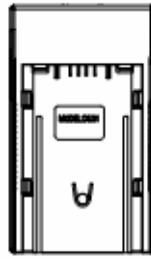

MODEL: DU21



MODEL: LP-E6

DV Battery Mount Plate:

DV Battery Mount Plate Specification:

Model DU21 for battery of Panasonic DV:
NV-GS/PV-GS/DZ-MV/GS/H28/H258/H288GK series, comply with
Panasonic battery DU06/VBD140/SANYO DZhs301sw/Hitachi
DZ-HS303SW/BZ-BP14S/DZ3200/BP07W.

Model QM91D for battery of SONY DV:
DSCR1/F/S/MVCCD/E/HC15E/HC1E/AE1u/DCRTRV828/E/CCD-TRV
116/DCR-DVD/PS105K/300K/10P/1E series.

Model F970 for battery of SONY DV:
DCR-TRV series, DCR-TRV E series, VX2100E PD P series, GV-A700,
GV-D800 FD/CCD-SC/TR3/FX1E/HVR-AIC, HDR-FX1000E, HVR-Z1C,
HVR-V1C, FX7E F330.

Model LP-E6 for battery of Canon DSLR:
5D Mark II/5D Mark III/EOS7D/EOS60D;

Wiring Instructions

❖ Video Output Cable

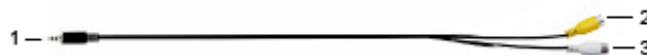

1. Video output interface.
2. Yellow: video 1 output plug.
3. White: video 2 output plug.

❖ Video Input Cable

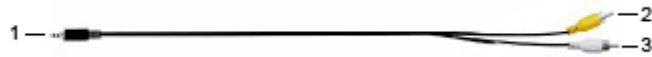

1. Video input interface.
2. Yellow: video 1 input plug.
3. White: video 2 input plug.

Menu Settings

Before setting the functions, please make sure the device is connected correctly.

Shortcut keys

The image menu

When power on, press “< / >” key on the device, brightness will appear at the bottom of the screen, then press the MENU button to select brightness, sharpness, contrast, saturation, volume, tint, MENU and Exit. User can adjust the parameters of the selected item with “< / >” button to meet their needs.



F1-F2 user-definable function buttons

Long press any F1-F2 key for 3-5 seconds to pop-up shortcut menu directly. As shown in Figure (default menu button in white font).

Use “< / >” buttons to select the desired option.

Finally, use the “ENTER” key to confirm the selected item as default.

Functions of F1-F3 buttons can also be customized: Center Marker, Safety Marker, Check Field, Color Bar, Aspect Ratio, Camera, Image Flip, Zoom, Pixel-to-Pixel, Freeze Input, Underscan, H/V delay.

Center Marker
Safety Marker
Check Field
Color Bar
Aspect Ratio
Camera
Image Flip
Zoom
Pixel-to-Pixel
Freeze Input
Underscan
H/V delay

Icon Display

Icons will display on screen when signal connected.

Select “Marker” on menu, and turn off “FPV Marker. And the icons will be invisible on screen.”

- Battery: battery level indicator.
- Voltage: voltage indicator (invisible when charging)
- Timer: available for flying countdown or battery level countdown.
- Channel frequency: searching channel automatically.
- Signal: wireless signal sensitivity indicator.

Menu Operation

When power on, press “MENU” on the device. The menu of function setting will display on the screen.

Press < / > buttons to choose menu; then press ENTER to confirm; after that, press MENU to return.

PICTURE

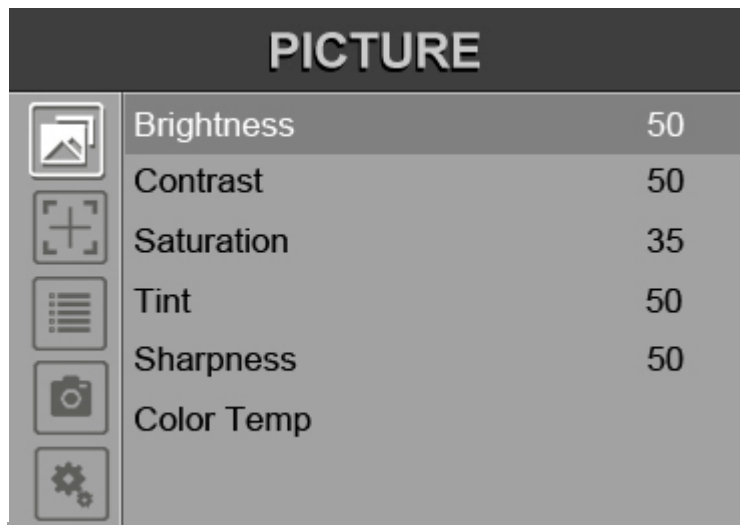

ITEMS	OPTIONS	
Brightness	0 – 100	
Contrast	0 – 100	
Saturation	0 – 100	
Tint	0 – 100	
Sharpness	0 – 100	
Color Temp	6500K, 7300K, 9300K, User	
	Color Temp R	Note: Available only under “User” mode to choose the color value you need.
	Color Temp G	
	Color Temp B	

MARKER



ITEMS	OPTIONS
Center Marker	ON, OFF
Safety Marker	OFF, 95%, 93%, 90%, 88%, 85%, 80%

DISPLAY

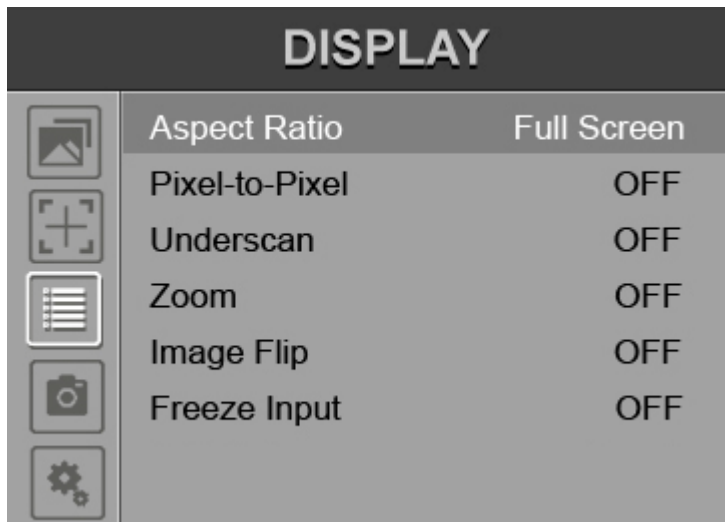





ITEMS	OPTIONS
Aspect Ratio	Full Screen, 4: 3, 16: 9, 1.85: 1, 2.35: 1
Pixel-to-Pixel	ON, OFF
Underscan	ON, OFF
Zoom	OFF, ×2, ×4, ×6, ×8
Image Flip	OFF, H, V, H / V
Freeze Input	ON, OFF

DSLR AUX & AUDIO

DSLR AUX&AUDIO		
	Camera	OFF
	H / V Delay	OFF
	Check Field	OFF
	Color Bar	OFF
	Volume	50

ITEMS	OPTIONS
Camera	ON, OFF (Only HDMI mode)
H / V Delay	OFF, H&V, V, H
Check Field	OFF, Mono, Red, Green, Blue
Color Bar	ON, OFF
Volume	0 – 100

SYSTEM

SYSTEM		
	Language	English
	LOGO	ON
	Back Light	100
	Manufacturer Default	OFF
	ISP	

ITEMS	OPTIONS
Language	English, Chinese
LOGO	ON, OFF
Back Light	0 – 100
Manufacture Default	ON, OFF
ISP	

Technical Specifications

Panel	7" LED Backlit (IPS)
Physical Resolution	1280×800
Brightness	400cd/m ²
Contrast	800:1
Viewing Angle	178°/178° (H/V)
Input Voltage	DC 7~24V
Aspect Ratio	16:9
Current	580mA
Power Consumption	≤7W
Operating Temperature	-20°~ 60°C
Storage Temperature	-30°~ 70°C
Dimension (LWD)	185×126×30 (mm)
Weight	360g

Trouble Shooting

1. Only black-and-white display

Check whether the brightness or color saturation is properly setup or not.

2. No image

Check the power input and connection

3. When on the picture shows size error

Press “MENU → DISPLAY → Underscan” to zoom in/out pictures automatically when receiving HDMI signals

4. Other problems

Please choose “MENU→SYSTEM→ Manufacturer Default →ON”

Note: due to constant effort to improve products and product features, specifications may change without notice.